

Article number: 54810052061

Description: 4 hole Flange Unit SSUCF206 for shaft $\varnothing 30\text{mm}$
Massive stainless steel, mat

Measures

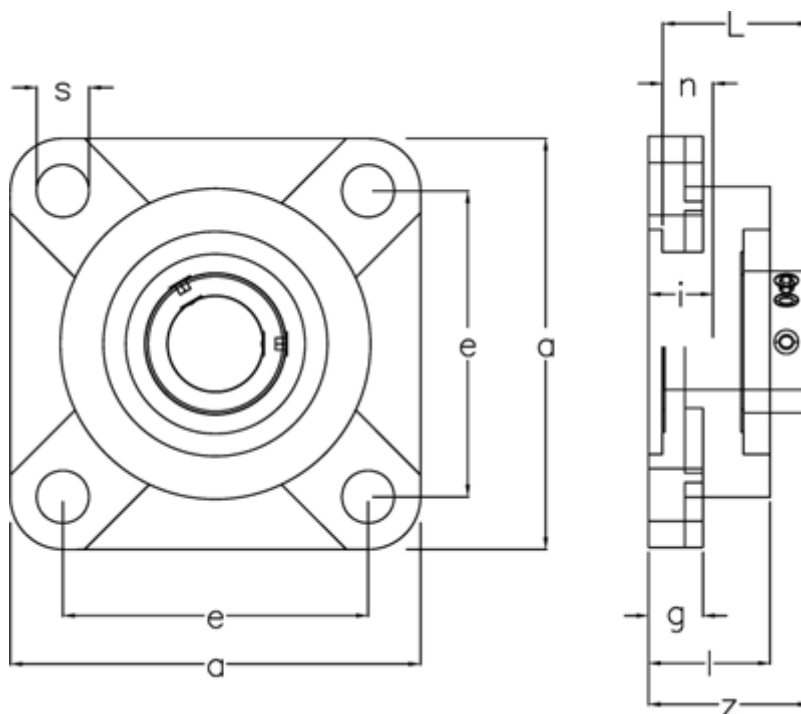

a	= 108	L	= 38.1
Bearing	= SUC206	Nominal drive	= 15.9
Bolt size	= M14	s	= 13
e	= 83	Weight	= 1.21
g	= 14.0	z	= 40.2
Housing	= SF206		
i	= 18		
l	= 31.0		